



**PAVLÍNEK**<sup>®</sup>  
VÁZACÍ PROSTŘEDKY

EMAIL: [OBCHOD@PAVLINEK.CZ](mailto:OBCHOD@PAVLINEK.CZ)  
TEL: +420 595 693 911  
ŠALOUNOVA 746/31, OSTRAVA VÍTKOVICE  
IČ: 25358511 DIČ: CZ25358511



## Standard equipment to Vaculyft machines

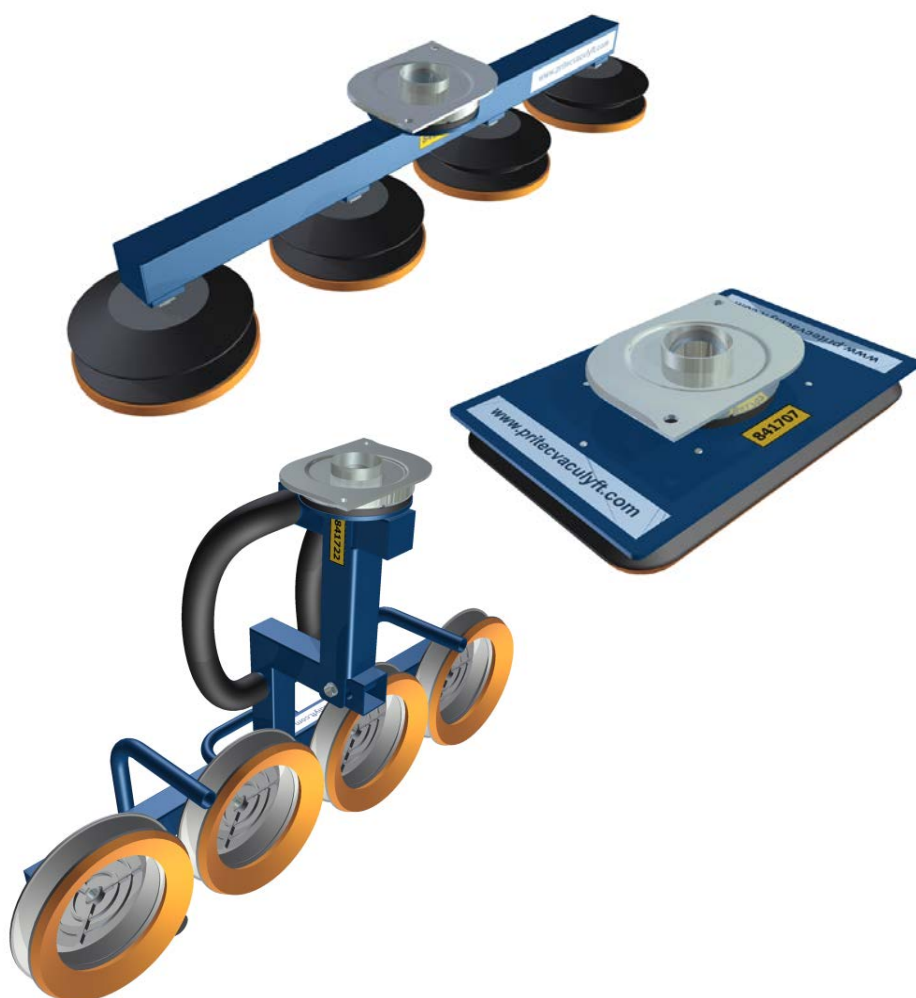

Pritec Vaculyft AB  
Fjärås Industriväg 9  
439 74 FJÄRÅS  
Sweden

Tel: +46 300- 543 543  
Email: [info@pritecvaculyft.com](mailto:info@pritecvaculyft.com)  
[www.pritecvaculyft.com](http://www.pritecvaculyft.com)



## 841701

Used to:  
Slabs 21x21cm 4pc, Kerbs, Block, Wallstone etc.  
Up to 140kg

Lift tube Ø (mm)	140	160	180	200	250
	X	X	X		

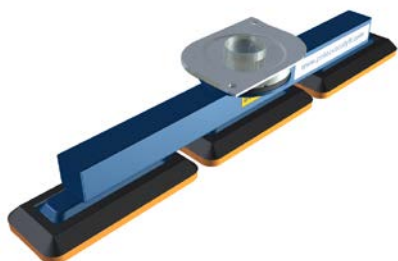

## 841702

Used to:  
Slabs 21x21cm 3pc, Kerbs Blockstone etc.  
Up to 80kg

Lift tube Ø (mm)	140	160	180	200	250
	X	X			



## 841703

Used to:  
Slabs 35x35cm 3pc, Kerbstone etc.  
Up to 80kg

Lift tube Ø (mm)	140	160	180	200	250
	X	X			



## 841704

Used to:  
Slabs 35x35cm 4pc, Kerbstone etc.  
Up to 100kg

Lift tube Ø (mm)	140	160	180	200	250
	X	X	X		



**PAVLÍNEK**<sup>®</sup>  
VÁZACÍ PROSTŘEDKY

EMAIL: [OBCHOD@PAVLINEK.CZ](mailto:OBCHOD@PAVLINEK.CZ)  
TEL: +420 595 693 911  
ŠALOUNOVA 746/31, OSTRAVA VÍTKOVICE  
IČ: 25358511 DIČ: CZ25358511





## 841705

Used to:  
Kerbstone 92x8,5cm.  
Up to 120kg

Lift tube Ø (mm)	140	160	180	200	250
	X	X	X		

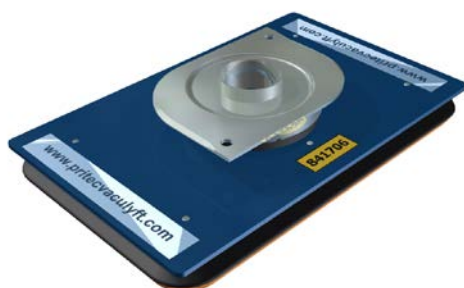

## 841706

Used to:  
Slabs 35x35cm and up, Block, Wallstone etc.  
Up to 140kg

Lift tube Ø (mm)	140	160	180	200	250
	X	X	X	X	

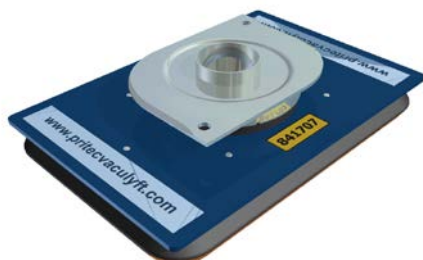

## 841707

Used to:  
Slabs 30x30cm and up, Block, Wallstone etc.  
Up to 100kg

Lift tube Ø (mm)	140	160	180	200	250
	X	X			

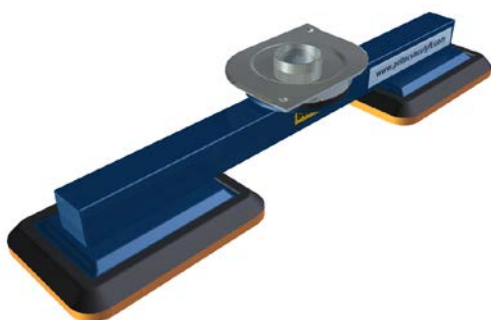

## 841708

Used to:  
Slabs 35x35cm 2pc, 40x40cm 3pc, 45x45cm 2pc  
Up to 80kg

Lift tube Ø (mm)	140	160	180	200	250
	X	X	X		



**PAVLÍNEK**<sup>®</sup>  
VÁZACÍ PROSTŘEDKY

EMAIL: [OBCHOD@PAVLINEK.CZ](mailto:OBCHOD@PAVLINEK.CZ)  
TEL: +420 595 693 911  
ŠALOUNOVA 746/31, OSTRAVA VÍTKOVICE  
IČ: 25358511 DIČ: CZ25358511



## 841709

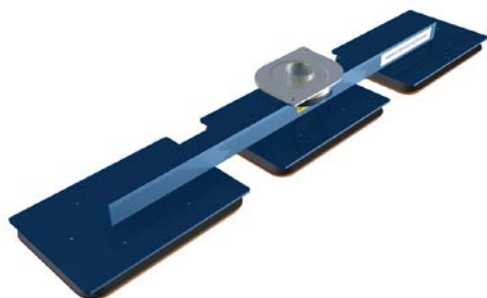

Used to:  
Slabs 35x35cm 3pc  
Up to 140kg

Lift tube Ø (mm)	140	160	180	200	250
	X	X	X	X	X

## 841711

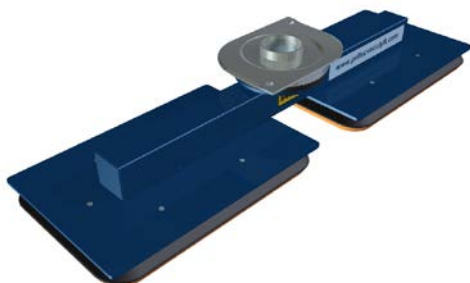

Used to:  
Slabs 35x35cm to 60x60cm 2pc Block Wallstone  
etc.  
Up to 140kg

Lift tube Ø (mm)	140	160	180	200	250
	X	X	X	X	X

## 841716

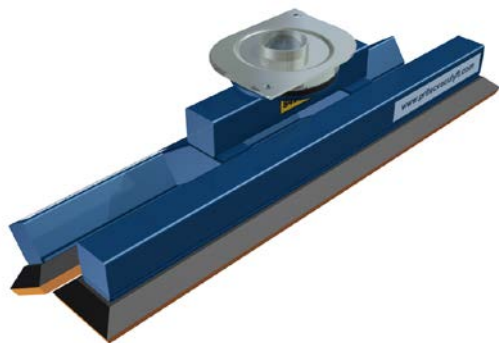

Used to:  
Kerbstone angled 45°  
Up to 140kg

Lift tube Ø (mm)	140	160	180	200	250
	X	X	X	X	

## 841718

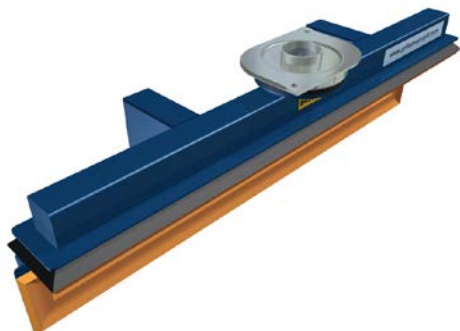

Used to:  
Kerbstone  
Up to 140kg

Lift tube Ø (mm)	140	160	180	200	250
	X	X	X	X	X



**PAVLÍNEK**<sup>®</sup>  
VÁZACÍ PROSTŘEDKY

EMAIL: [OBCHOD@PAVLINEK.CZ](mailto:OBCHOD@PAVLINEK.CZ)  
TEL: +420 595 693 911  
ŠALOUNOVA 746/31, OSTRAVA VÍTKOVICE  
IČ: 25358511 DIČ: CZ25358511



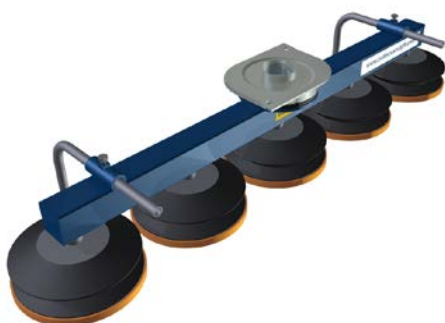

## 841719

Used to:  
Slabs 17x17cm 5pc  
Up to 140kg

Lift tube Ø (mm)	140	160	180	200	250
	X	X	X	X	

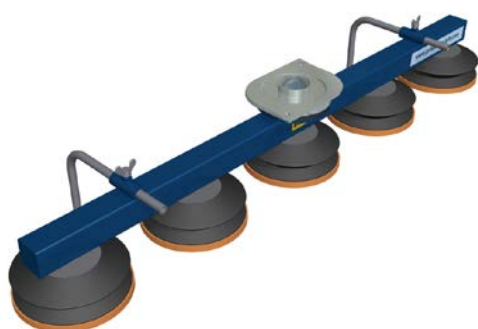

## 841720

Used to:  
Multi: 21x21cm 5pc, 30x30cm 4pc  
Up to 120kg

Lift tube Ø (mm)	140	160	180	200	250
	X	X	X		

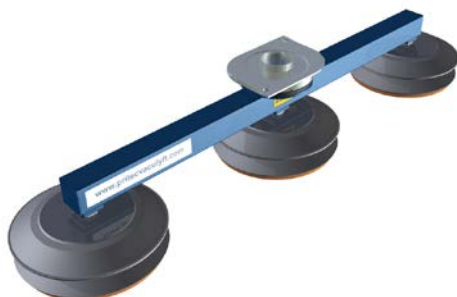

## 841721

Used to:  
Slabs 35x35cm 3pc  
Up to 140kg

Lift tube Ø (mm)	140	160	180	200	250
	X	X	X	X	



## 841722

Used to:  
Granit Kerbstone tilt function.  
Up to 140kg

Lift tube Ø (mm)	140	160	180	200	250
	X	X	X	X	



**PAVLÍNEK**<sup>®</sup>  
VÁZACÍ PROSTŘEDKY

EMAIL: [OBCHOD@PAVLINEK.CZ](mailto:OBCHOD@PAVLINEK.CZ)  
TEL: +420 595 693 911  
ŠALOUNOVA 746/31, OSTRAVA VÍTKOVICE  
IČ: 25358511 DIČ: CZ25358511



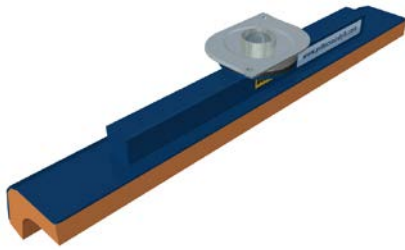

## 841723

Used to:  
Kerbstone typ Spikma  
Up to 140kg

Lift tube Ø (mm)	140	160	180	200	250
	X	X	X	X	



## 841724

Used to:  
Block 21x21cm 3pc etc.  
Up to 100kg

Lift tube Ø (mm)	140	160	180	200	250
	X	X	X		



## 841725

Used to:  
Circus St Erics  
Up to 140kg

Lift tube Ø (mm)	140	160	180	200	250
	X	X	X	X	

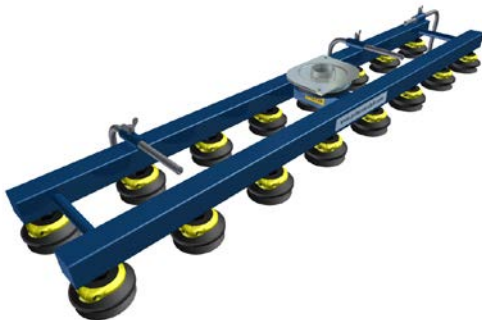

## 841726

Used to:  
Superförband 2 rows  
Up to 140kg

Lift tube Ø (mm)	140	160	180	200	250
	X	X	X		



**PAVLÍNEK**<sup>®</sup>  
VÁZACÍ PROSTŘEDKY

EMAIL: [OBCHOD@PAVLINEK.CZ](mailto:OBCHOD@PAVLINEK.CZ)  
TEL: +420 595 693 911  
ŠALOUNOVA 746/31, OSTRAVA VÍTKOVICE  
IČ: 25358511 DIČ: CZ25358511



## 841727

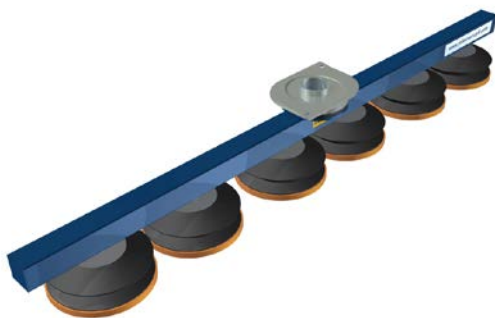

Used to:  
Multi: 21x21cm 6ps, 21x21cm 5pc, 35x35cm 3pc  
Up to 140kg  
Option: 30x30cm 4pc

Lift tube Ø (mm)	140	160	180	200	250
	X	X	X	X	

## 641009

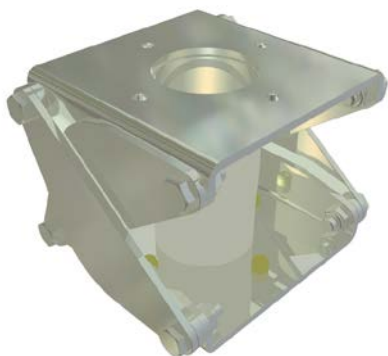

Angle adapter 0-90°, For vertical handling

## 841728

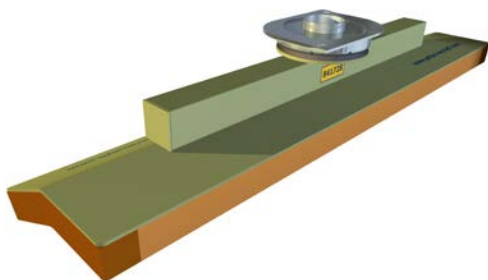

Used to:  
Kerbstone type Trottoirband  
Up to 140kg

Lift tube Ø (mm)	140	160	180	200	250
	X	X	X	X	

## 841731

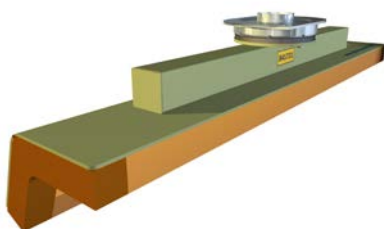

Used to:  
Kerbstone Norway  
Up to 120kg

Lift tube Ø (mm)	140	160	180	200	250
	X	X	X	x	



**PAVLÍNEK**<sup>®</sup>  
VÁZACÍ PROSTŘEDKY

EMAIL: [OBCHOD@PAVLINEK.CZ](mailto:OBCHOD@PAVLINEK.CZ)  
TEL: +420 595 693 911  
ŠALOUNOVA 746/31, OSTRAVA VÍTKOVICE  
IČ: 25358511 DIČ: CZ25358511



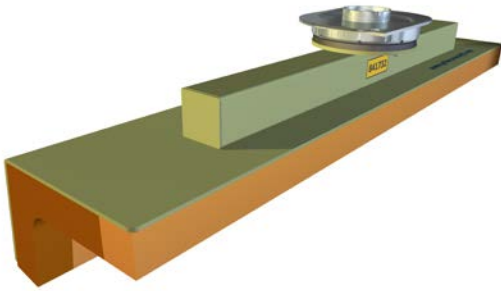

## 841732

Used to:  
Kerbstone Netherlands  
Up to 140kg

Lift tube Ø (mm)	140	160	180	200	250
	X	X	X	X	

## 841733

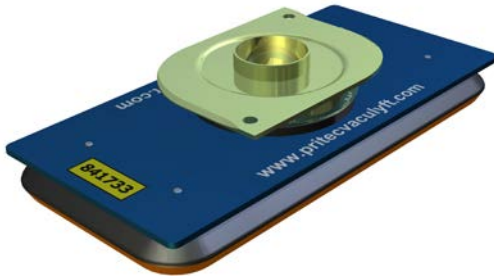

Used to:  
Slabs wall 15x33cm  
Up to 80kg

Lift tube Ø (mm)	140	160	180	200	250
	X	X			

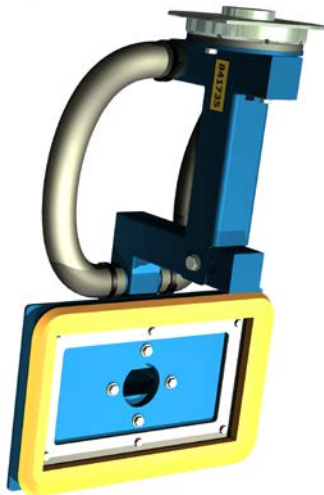

## 841735

Used to:  
Kerb, wall stone side lift. 21x33cm  
Up to 120kg

Lift tube Ø (mm)	140	160	180	200	250
	X	X	X		

## 841736

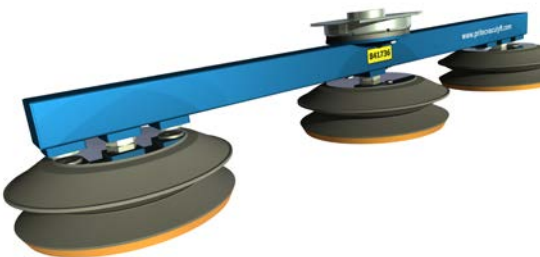

Used to:  
Multi: Slabs 3x Ø200 30+35+40cm/cc  
Up to 140kg

Lift tube Ø (mm)	140	160	180	200	250
	X	X	X	X	



**PAVLÍNEK**<sup>®</sup>  
VÁZACÍ PROSTŘEDKY

EMAIL: [OBCHOD@PAVLINEK.CZ](mailto:OBCHOD@PAVLINEK.CZ)  
TEL: +420 595 693 911  
ŠALOUNOVA 746/31, OSTRAVA VÍTKOVICE  
IČ: 25358511 DIČ: CZ25358511







## 841737

Used to:  
Kerstone radius adjustable Ø200x4  
Up to 140kg

Lift tube Ø (mm)	140	160	180	200	250
	X	X	X	X	



## 841738

Used to:  
Slabs side shift 21x14cm  
Up to 140kg

Lift tube Ø (mm)	140	160	180	200	250
	X	X	X	X	



## 841739

Used to:  
Slabs side shift 20x20cm  
Up to 140kg

Lift tube Ø (mm)	140	160	180	200	250
	X	X	X	X	

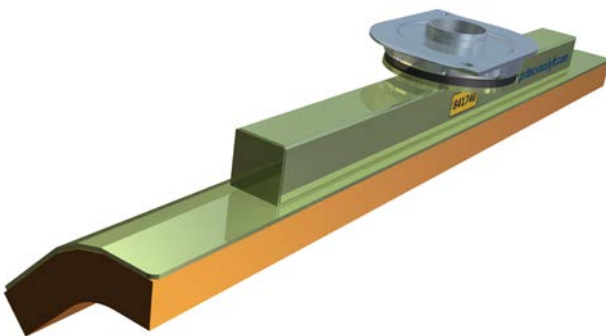

## 841740

Used to:  
Kerstone Spikma A100  
Up to 140kg

Lift tube Ø (mm)	140	160	180	200	250
	X	X	X	X	



**PAVLÍNEK**<sup>®</sup>  
VÁZACÍ PROSTŘEDKY

EMAIL: [OBCHOD@PAVLINEK.CZ](mailto:OBCHOD@PAVLINEK.CZ)  
TEL: +420 595 693 911  
ŠALOUNOVA 746/31, OSTRAVA VÍTKOVICE  
IČ: 25358511 DIČ: CZ25358511





## 841742

Used to:  
Slabs side shift 20x13cm  
Up to 140kg

Lift tube Ø (mm)	140	160	180	200	250
	X	X	X	X	

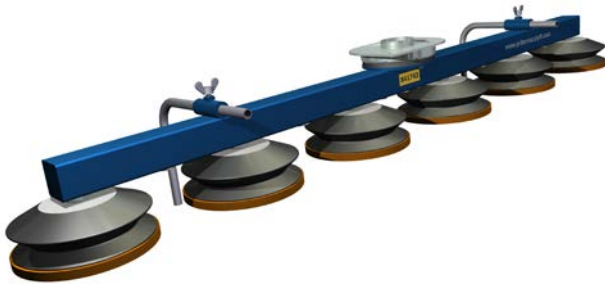

## 841743

Used to:  
Slabs 1 row (5 or 6 pcs) 21x21cm  
Up to 140kg

Lift tube Ø (mm)	140	160	180	200	250
	X	X	X	X	



## 841744

Used to:  
Slabs side shift 19,5x13cm  
Up to 140kg

Lift tube Ø (mm)	140	160	180	200	250
	X	X	X	X	



## 841745

Used to:  
Slabs side shift Kartano  
Up to 140kg

Lift tube Ø (mm)	140	160	180	200	250
	X	X	X	X	



**PAVLÍNEK**<sup>®</sup>  
VÁZACÍ PROSTŘEDKY

EMAIL: [OBCHOD@PAVLINEK.CZ](mailto:OBCHOD@PAVLINEK.CZ)  
TEL: +420 595 693 911  
ŠALOUNOVA 746/31, OSTRAVA VÍTKOVICE  
IČ: 25358511 DIČ: CZ25358511





## 841746

Used to:  
Slabs side shift 40x20cm(6pcs) and 20x20cm  
(12pcs)  
Up to140kg

Lift tube Ø (mm)	140	160	180	200	250
	X	X	X	X	



## 841747

Used to:  
Slabs Windermere  
Up to140kg

Lift tube Ø (mm)	140	160	180	200	250
	X	X	X	X	



## 841750-024

Used to:  
Scissors tool grass reinforcement and wall stone  
Up to140kg

Lift tube Ø (mm)	140	160	180	200	250
	X	X	X	X	X



**PAVLÍNEK**<sup>®</sup>  
VÁZACÍ PROSTŘEDKY

EMAIL: [OBCHOD@PAVLINEK.CZ](mailto:OBCHOD@PAVLINEK.CZ)  
TEL: +420 595 693 911  
ŠALOUNOVA 746/31, OSTRAVA VÍTKOVICE  
IČ: 25358511 DIČ: CZ25358511

